

Mayfield bench/table

Technical Informations

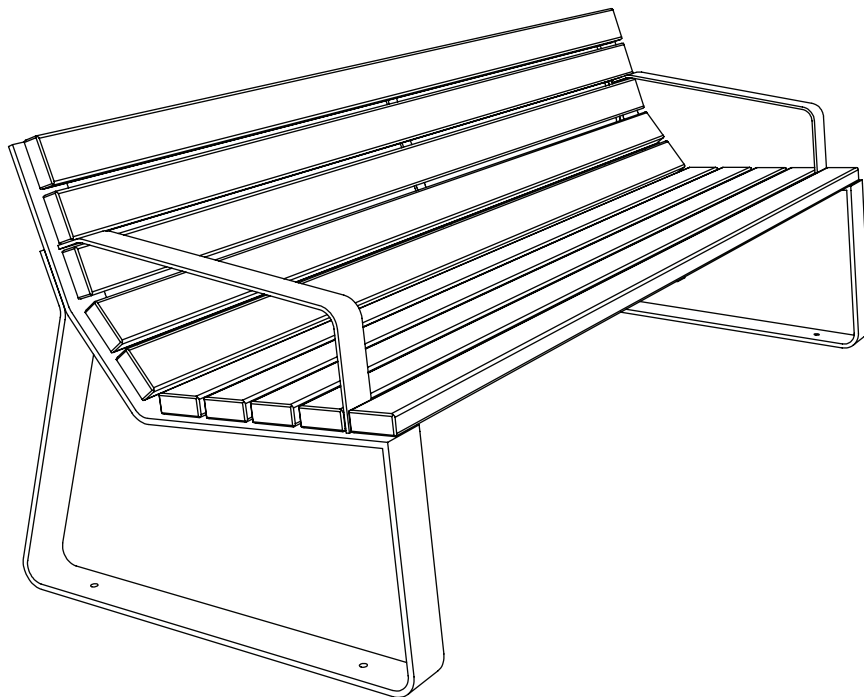

Dimensions

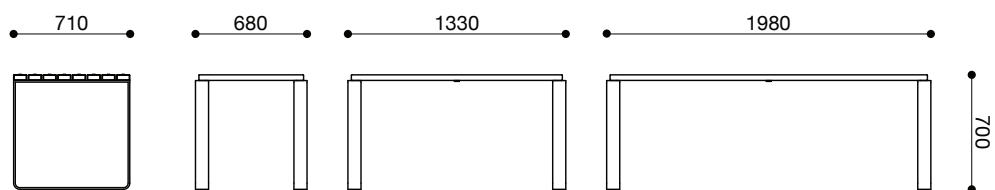
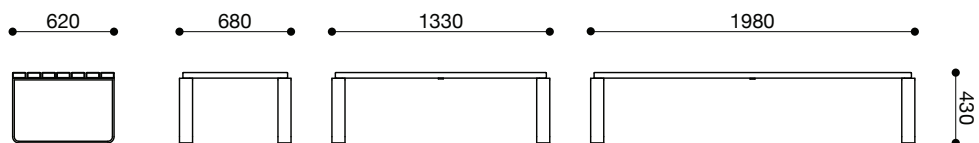
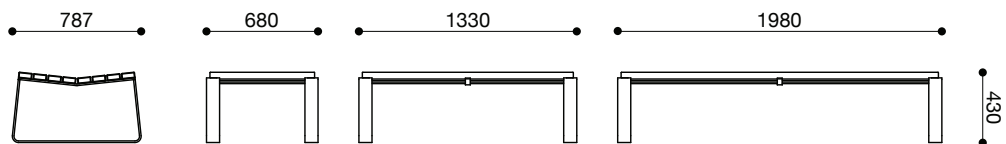
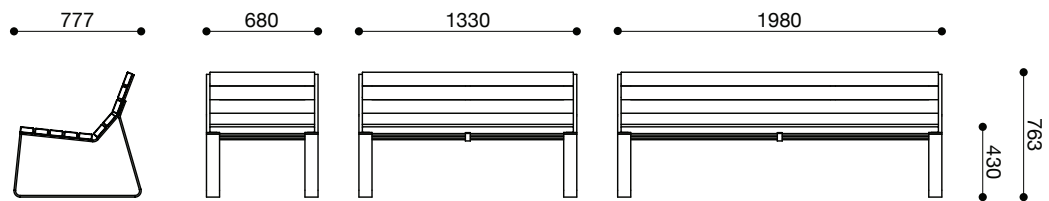
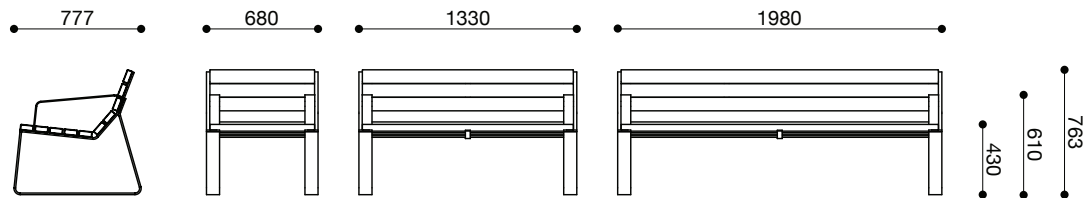

Hole pattern for mounting

- 1) With backrest
- 2) Without backrest
- 3) Table low
- 4) Table high

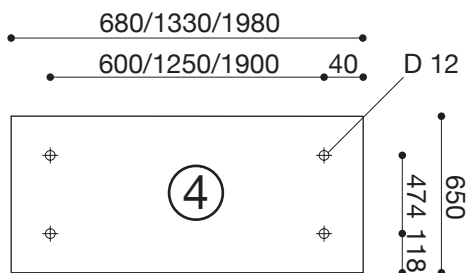
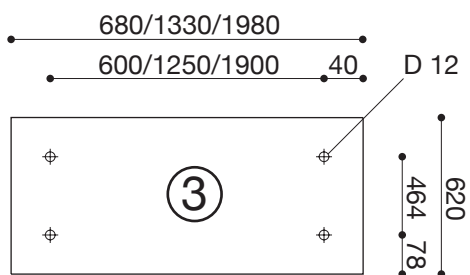
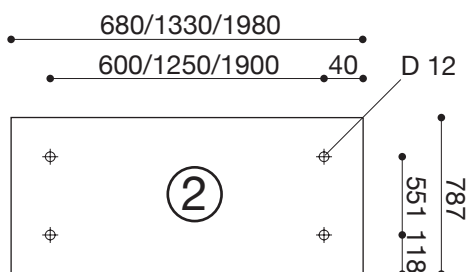
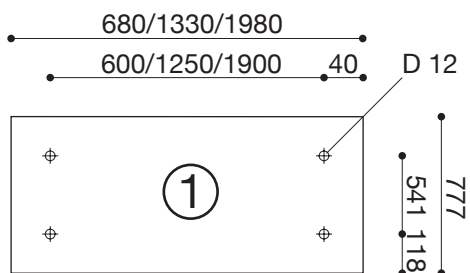

Mounting

Without foundation
with threaded rod

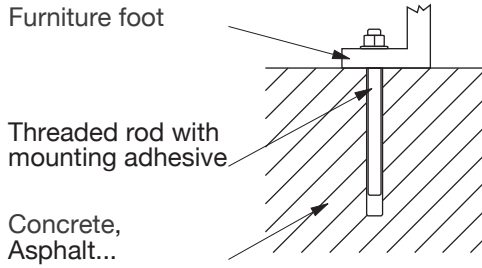

With foundation
with threaded rod

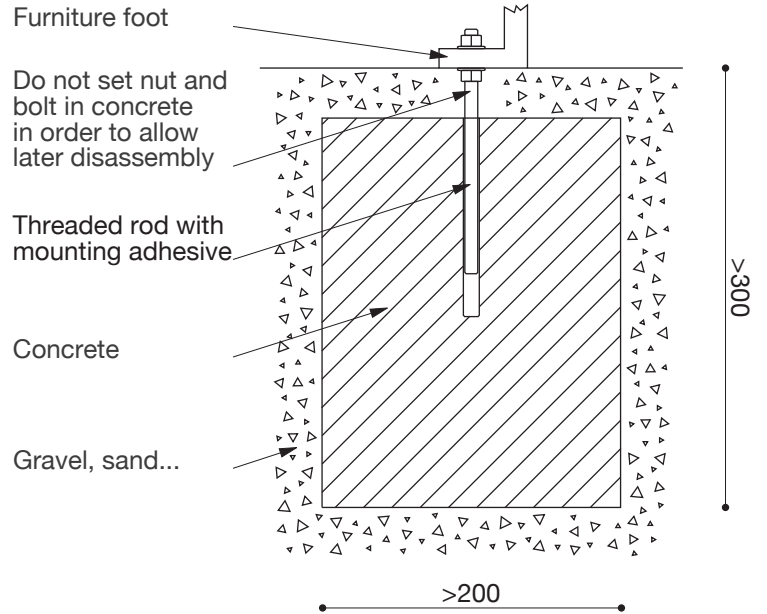

Without foundation
with screw and dowel

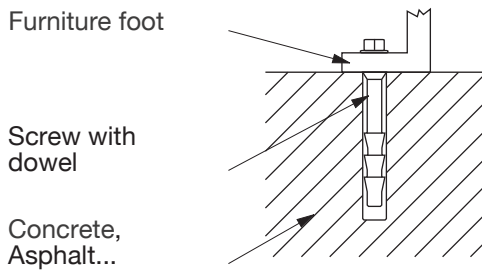

With foundation
with ground anchor

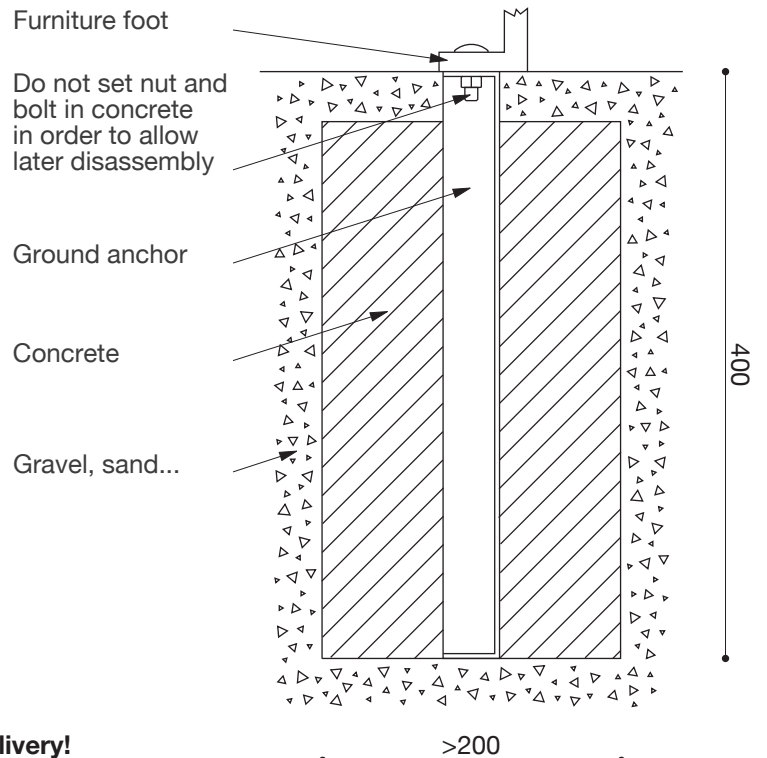

The fasteners are not included in the scope of delivery!